

Dot



Code article	86.OP01.1010.01
Type de produit	Extérieur
Catégorie	Pixel Light
Famille	Dot

Pictograms



Dessin technique

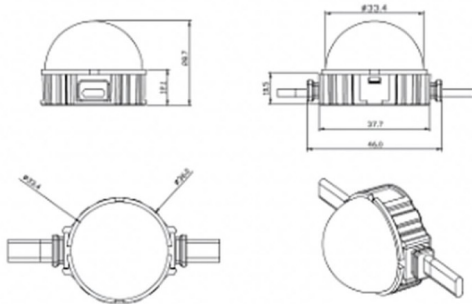

Produit	
Puissance système (W)	0.9
Flux lumineux utile (lm)	25.83
Angle de faisceau	99.78
IP	66
Durée de vie utile (h)	80000h L70B10
Température de couleur (K)	RGB
Uniformité chromatique (SDCM)	SDCM3